



GLASBESCHLÄGE  
*FERREMENTS POUR VITRAGES*

# Aweso Aperto® 268

**Beschläge für Hubschalter**  
Für 6-mm-Glas, in Aluminium

*Ferremets pour guichets à guillotine*  
*Pour verre de 6 mm, en aluminium*

**AWESO**  
INDIVIDUELLES AUS METALL  
LE MÉTAL INDIVIDUALISÉ

**Hubschalter mit Gegengewicht und Oberlicht**  
*Guichet à guillotine avec contre-poids et partie fixe*

**Aperto® 268**

**2680.300**

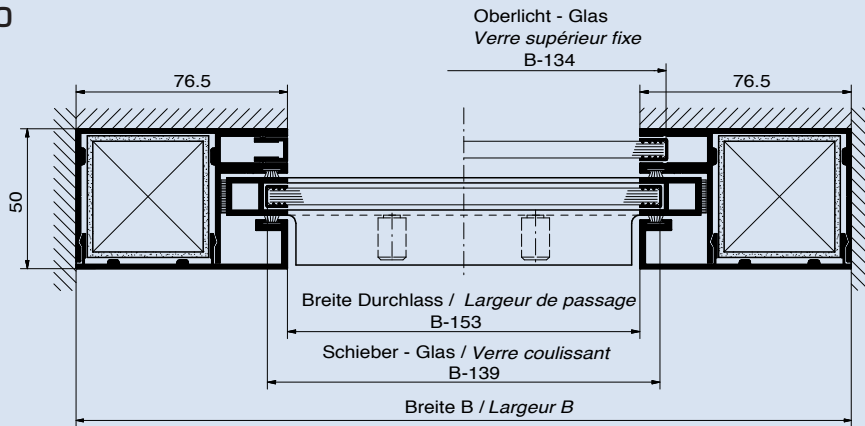

Horizontalschnitte  
*Coupes horizontales*

Max. Anlagengröße:  
*Dimension max.  
de l'installation :*  
**1300 x 1500 mm**

**2680.301**

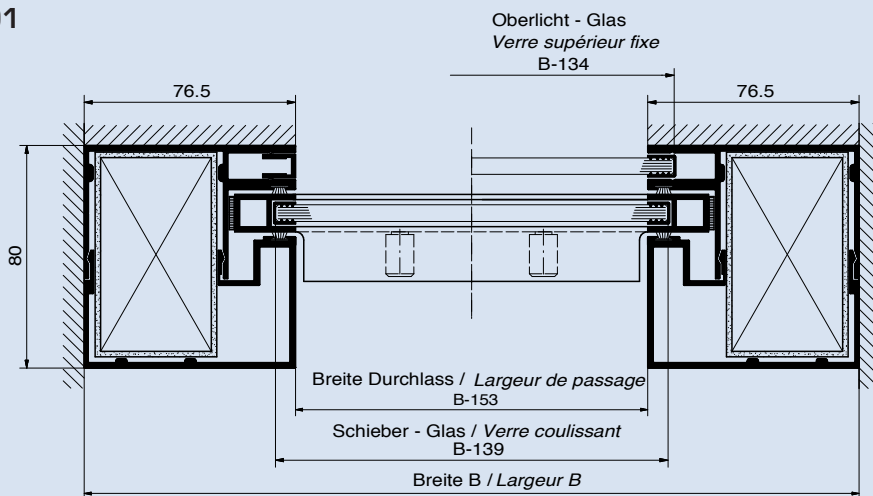

Max. Anlagengröße:  
*Dimension max.  
de l'installation :*  
**2000 x 2000 mm**

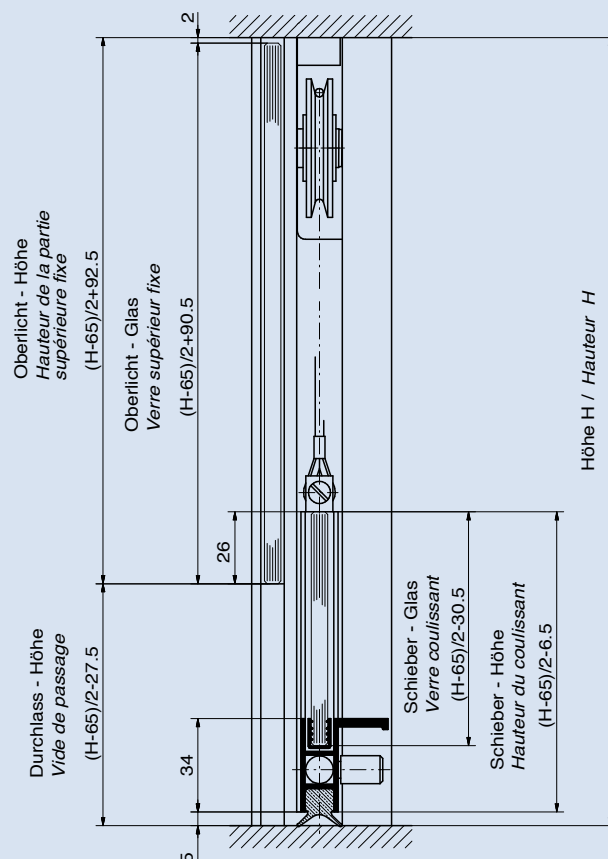

Vertikalschnitt  
*Coupe verticale*

2680.300/K

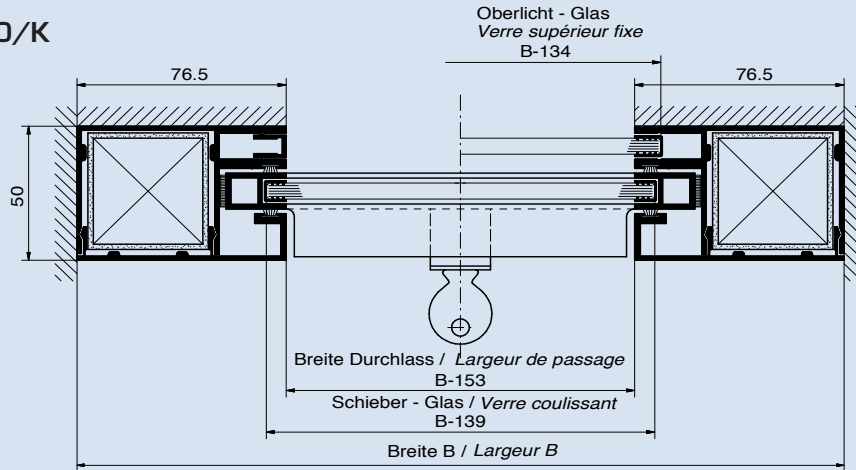

Horizontalschnitte  
 Coupes horizontales

Max. Anlagengröße:  
 Dimension max.  
 de l'installation :  
**1300 x 1500 mm**

2680.301/K

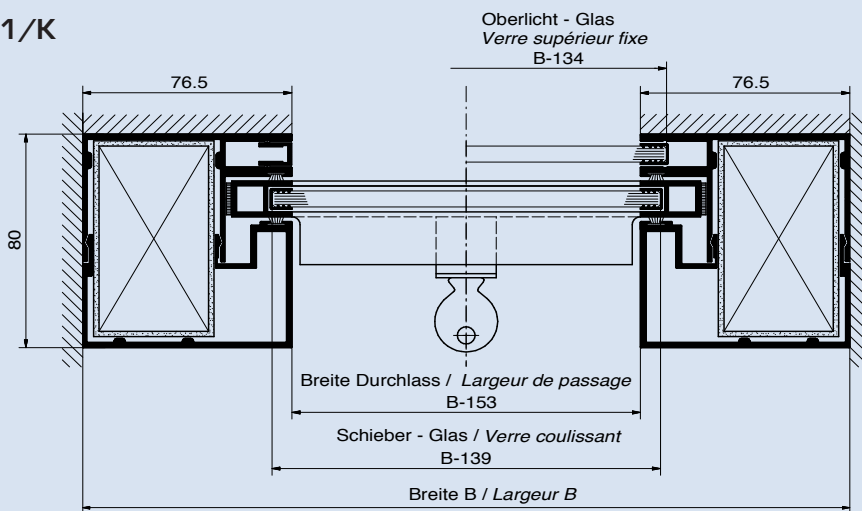

Max. Anlagengröße:  
 Dimension max.  
 de l'installation :  
**2000 x 2000 mm**

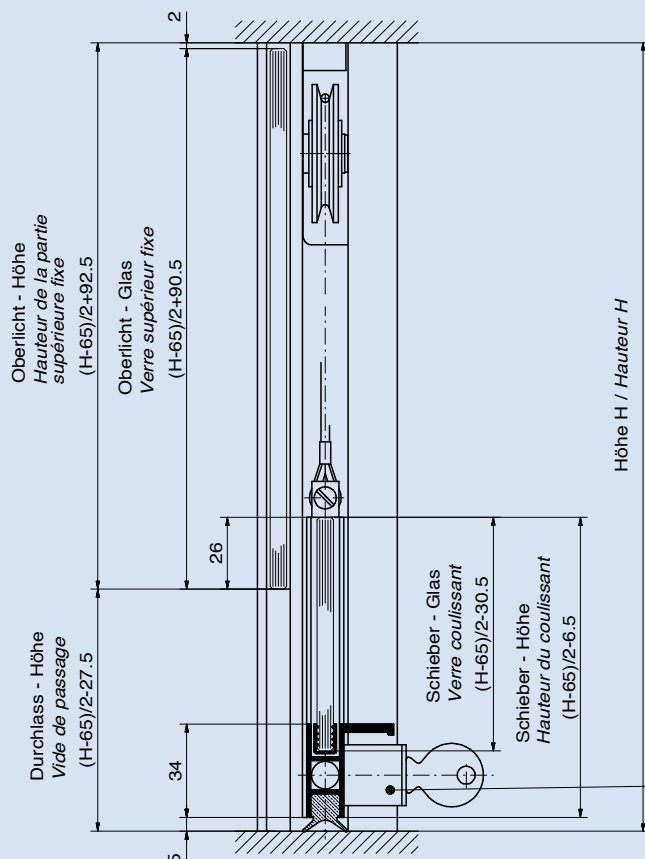

Vertikalschnitt  
 Coupe verticale

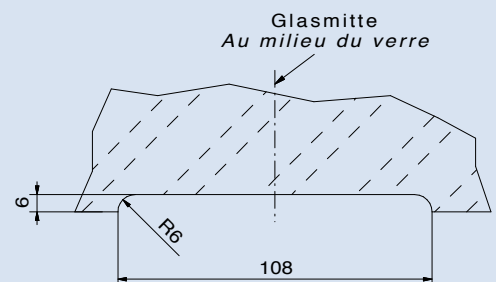

Kabaverschluss  
 Zyl. Typ: 1008 PA  
 Fermeture Kaba  
 Cylindre Type: 1008 PA

2680.302-303

Horizontalschnitt  
*Coupe horizontale*

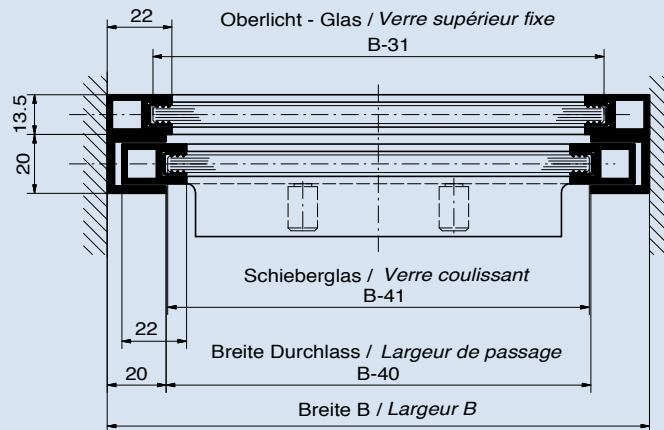

**Achtung: Schiebeflügel nur bis max. 2 kg**  
**Attention : Battant coulissant jusqu'à max. 2 kg**

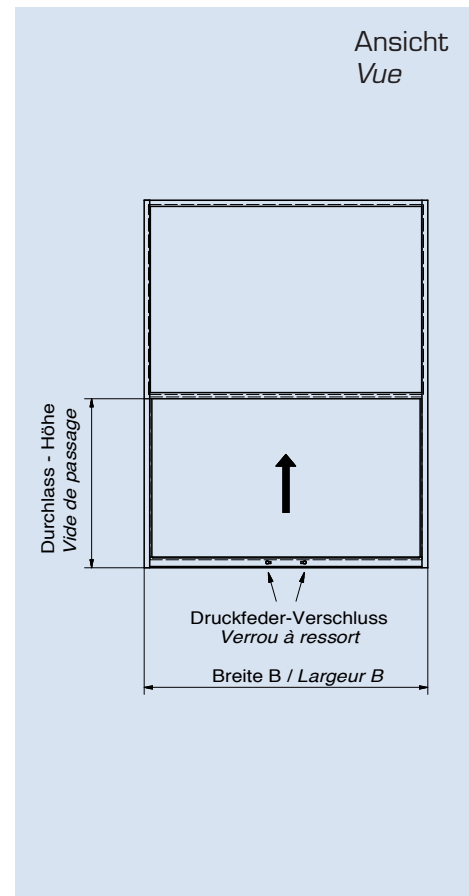
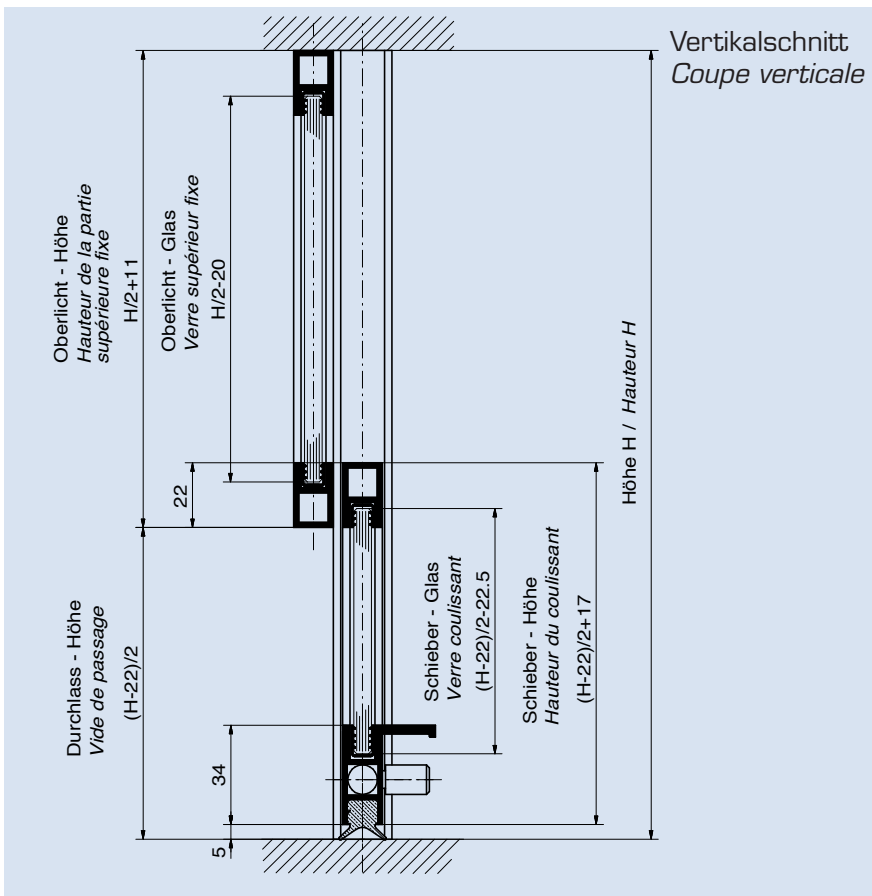

2680.302

Horizontalschnitt  
*Coupe horizontale*

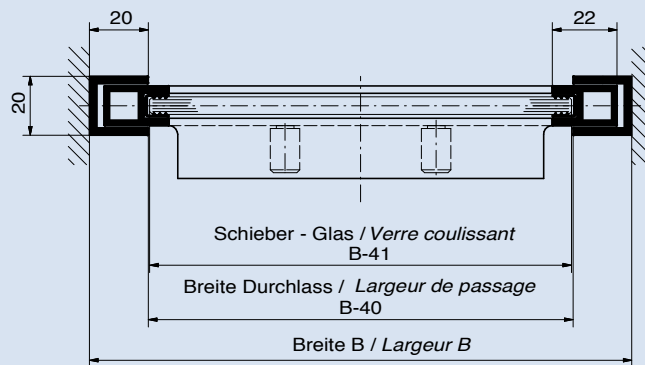

**Achtung: Schiebeflügel nur bis max. 2 kg**  
**Attention : Battant coulissant jusqu'à max. 2 kg**

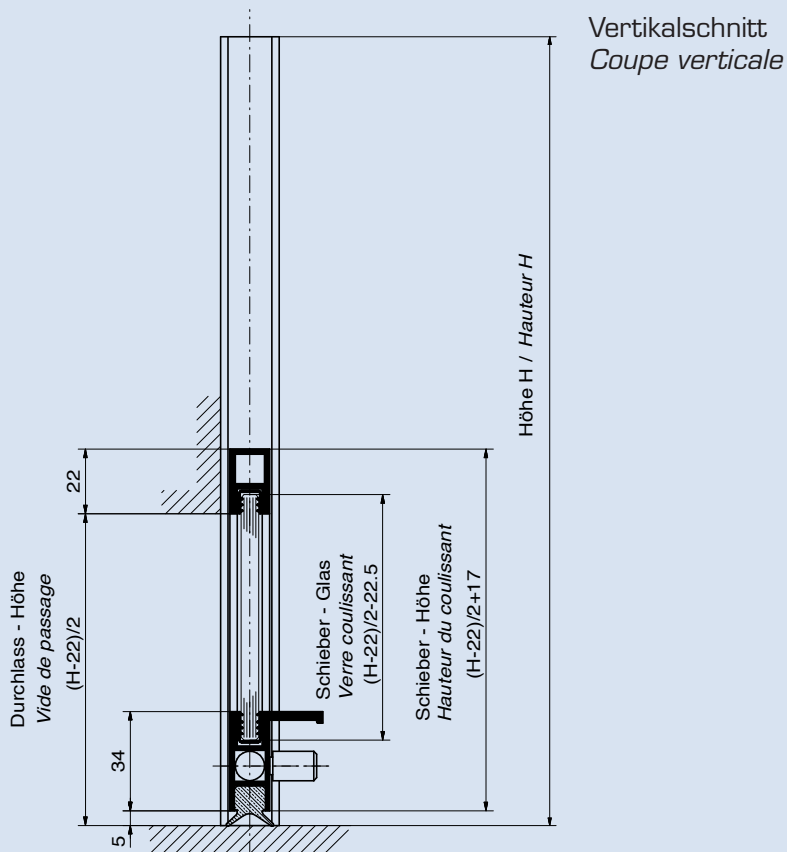

Vertikalschnitt  
*Coupe verticale*

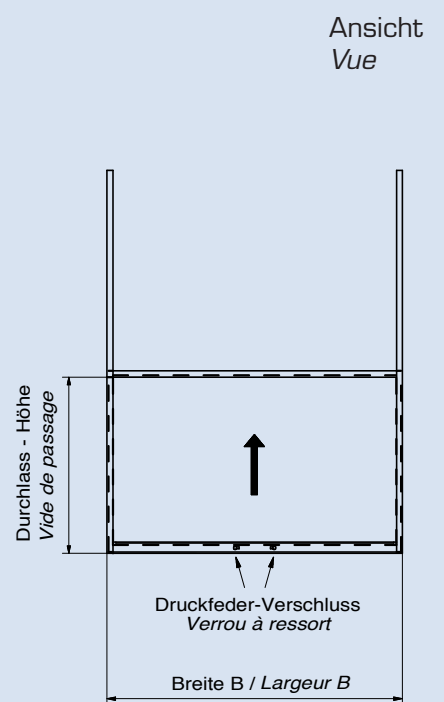

Ansicht  
*Vue*

Befestigung seitlich nach links und rechts  
*Fixation entre 2 murs*

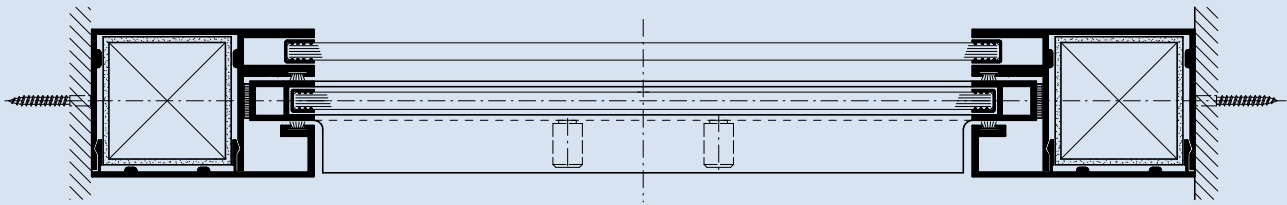

Befestigung nach hinten gegen Wand  
*Fixation contre le mur*

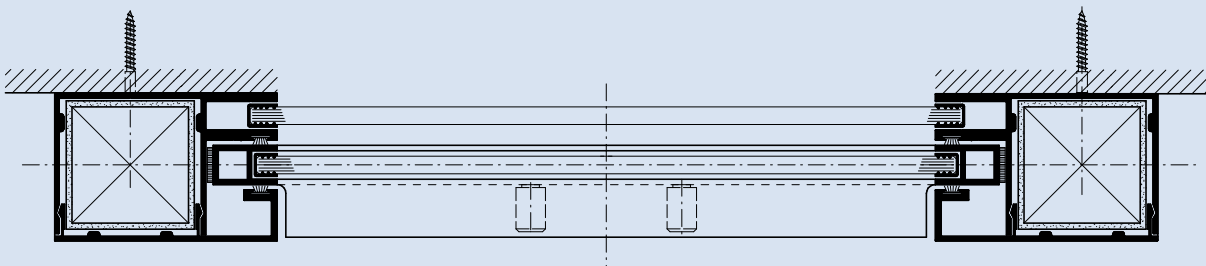

Befestigung nach oben und unten  
*Fixation en haut et en bas*

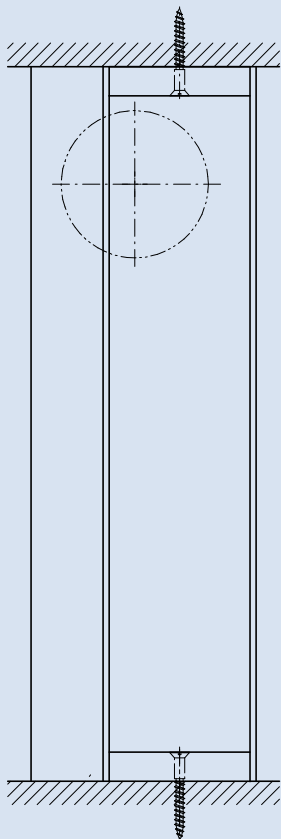

Übersicht  
*Vue d'ensemble*

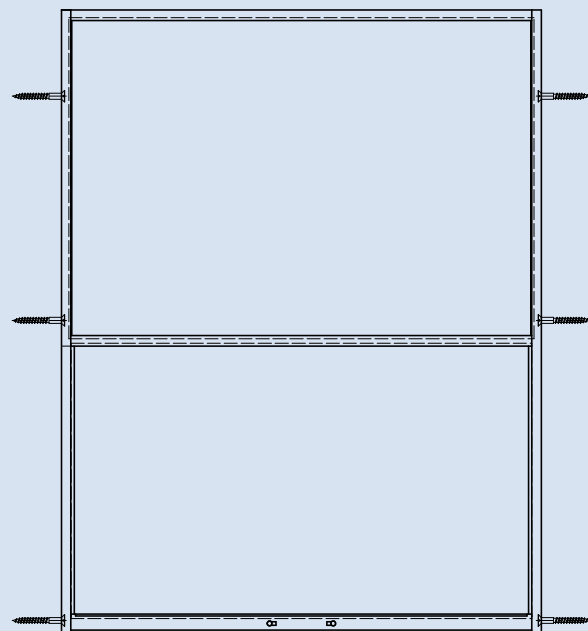

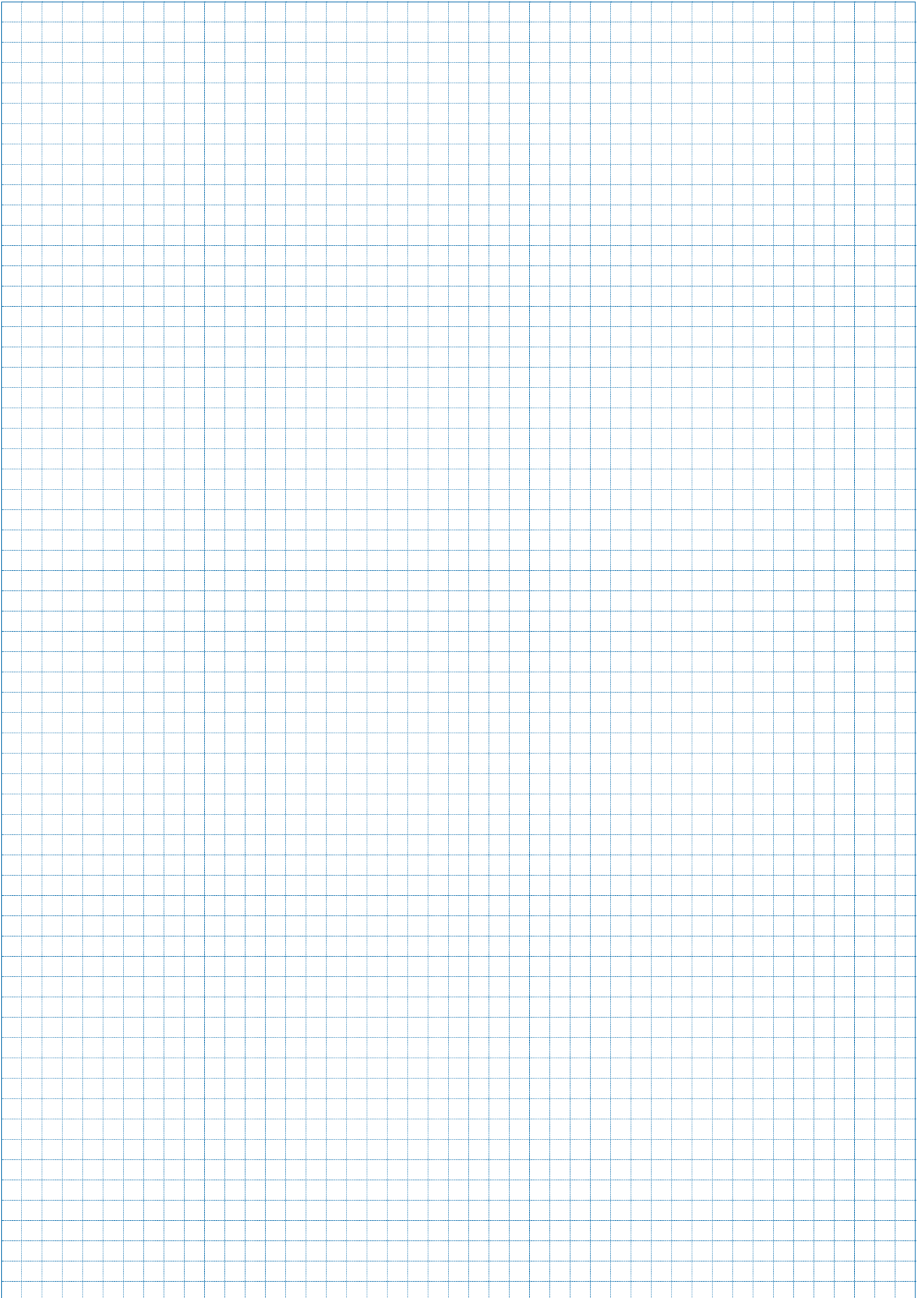

**BESCHLÄGE FÜR DEN INNENAUSBAU**  
**FERREMENTS POUR L'AMÉNAGEMENT**  
**SHOP FITTING SYSTEMS**

- Stellschienen und Konsolen
- Gondolen und Ständer
- Beschläge für Warenpräsentation und Innenausbau
- Scharniere, Griffe und Schlösser
- *Crémaillères et consoles*
- *Gondoles et rayonnages*
- *Ferrements pour la présentation de marchandises et l'aménagement d'intérieur*
- *Charnières, poignées et serrures*
- Channels and brackets
- Gondolas and centre floor units
- Accessories for shop fitting systems
- Hinges, handles and locks

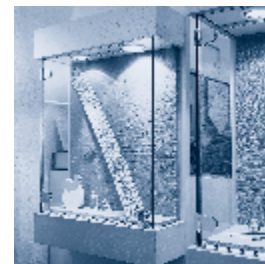

**GLASBESCHLÄGE**  
**FERREMENTS POUR VITRAGES**  
**GLASS MOUNTINGS**

- Glas-Schiebetüren
- Schalteranlagen / Hängeschieber / Hubschalter
- Brandschutzschalter
- Balkon- und Sitzplatzschieber
- Fassadenbeschläge
- *Portes coulissantes en verre*
- *Guichets / guichets suspendus / guichets à guillotine*
- *Guichets de protection anti-feu*
- *Coulissants pour balcons et terrasses vitrés*
- *Ferrements de façade*
- Glass sliding doors
- Counter units / sliding sash units
- Fire protection counter units
- Balcony and terrace sliding units
- Facade fittings



Aweso AG  
 Zürcherstrasse 35  
 Postfach 1227  
 CH-8620 Wetzikon  
 Tel. +41 (0)44 933 01 01  
 Fax +41 (0)44 933 01 06  
 info@aweso.ch  
 www.aweso.ch

Aweso Systemtechnik GmbH  
 Alpstraße 17  
 AT-6890 Lustenau  
 Tel. +43 (0)5577 82500  
 Fax +43 (0)5577 82500 4  
 office@aweso.at  
 www.aweso.at

Aweso (UK) Ltd.  
 Eastland House  
 50 Forge Lane  
 Halesowen  
 West Midlands B62 8EB - GB  
 Phone +44 121 550 87 67  
 Fax +44 121 550 87 76  
 sales@aweso.co.uk  
 www.aweso.co.uk